

SYMBOL DEFINITION		MISSING NUMBERS	
A DIMENSION WITHOUT AN INSPECTION REPORT SYMBOL  DOES NOT REQUIRE INSPECTION. IT MAY BE CONTROLLED ON AN INDIVIDUAL COMPONENT DRAWING	TOTAL NO. OF SYMBOLS ON DRAWING	10	
	LAST NO. USED	23	

DWG STATUS					ZONE	REVISION HISTORY	AUTH	DR	APVD1	APVD2
DATE	STG	REV	N/P	CHG						
28JNO1	R	001	-	-		ALL PARTS - 32.2 +0.15/-0.2 WAS 32.2 +0.15 & REVISED GRAPHICS	201448	HH	EOV	GMC
28JNO1	R	002	-	-		ALL PARTS - REVISED PSD	211556	HH	EOV	GMC
09JAO2	R	003	-	-		ALL PARTS - (32.2) WAS 32.2 +/-0.15	219258	HAM	HAM	ET
09AU05	R	04	-	-		ALL PARTS - RELAXED TOLERANCE 3 PLACS 12.3 TYP +0.3/-0.15 WAS 12.3 TYP , 12.3 TYP +0.3/-0.15 WAS 12.3 TYP AND 4X 2.25 TYP +0.15/-0.25 WAS 4X 2.25 TYP	270624	MM	MM	BG

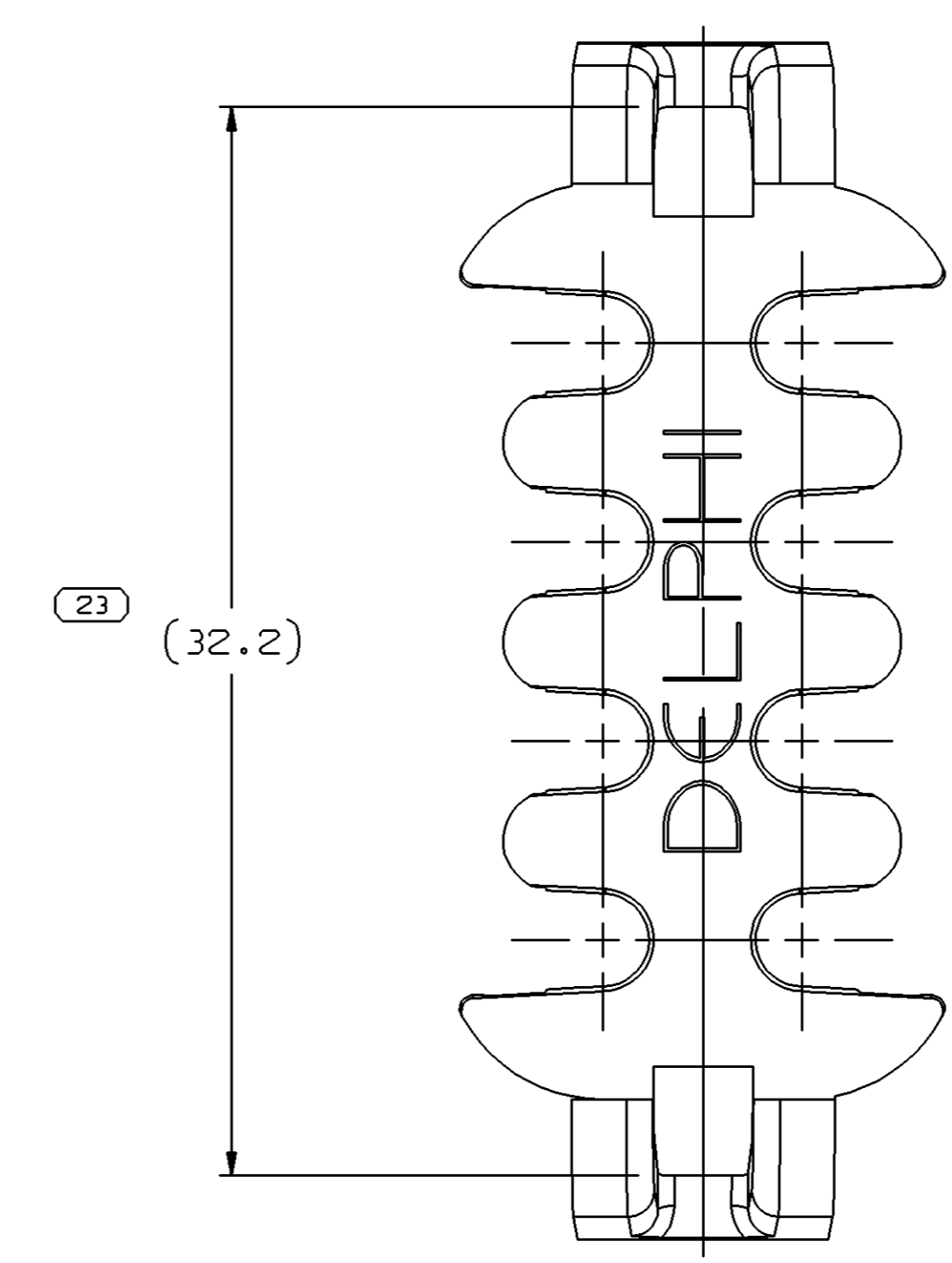

- NOTES
- UNLESS OTHERWISE SPECIFIED AND/OR INDICATED:  
DIMENSIONS ARE TO FACE OF VIEW SHOWN AND AUTOMATICALLY ROUNDED BY COMPUTER FOR INSPECTION (SEE MATH MODEL FOR PRECISE DIMENSIONS). FOR ALL OTHER DIMENSIONS NOT SHOWN BUT REQUIRED FOR TOOL BUILD, SEE MATH MODEL FOR PRECISE TOOL PATH DATA.
  - THIS PART IS NOT CONTROLLED FOR AUTOMATIC FEEDING.
  - MATING COMPONENTS OR EQUIVALENT:  
CONNECTOR 12047931, 12047933, 12052480, 12052601 AND 12103919.
  - MAX CABLE DIAMETER THAT FIT PART IS  $\phi 2.31$ .

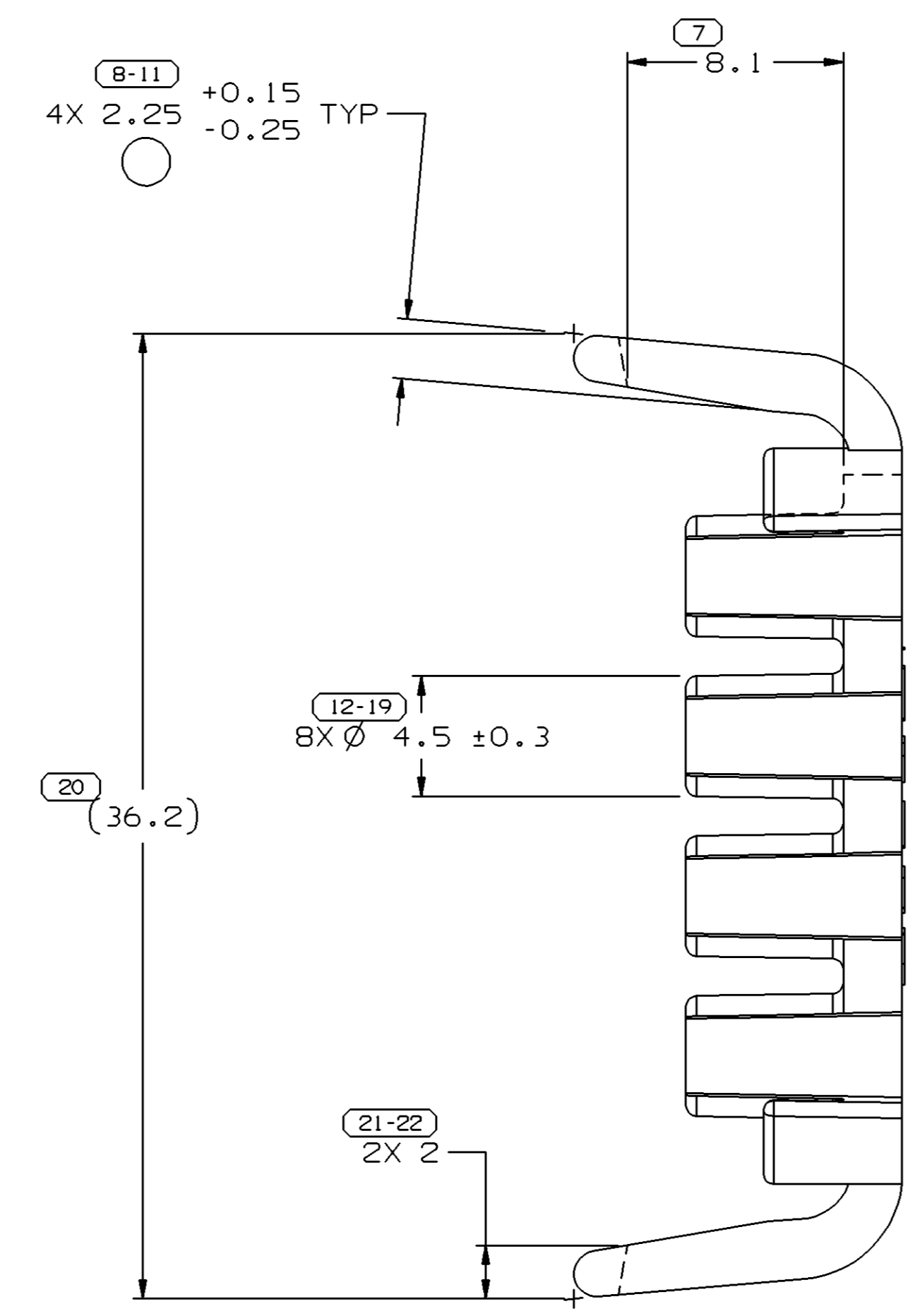
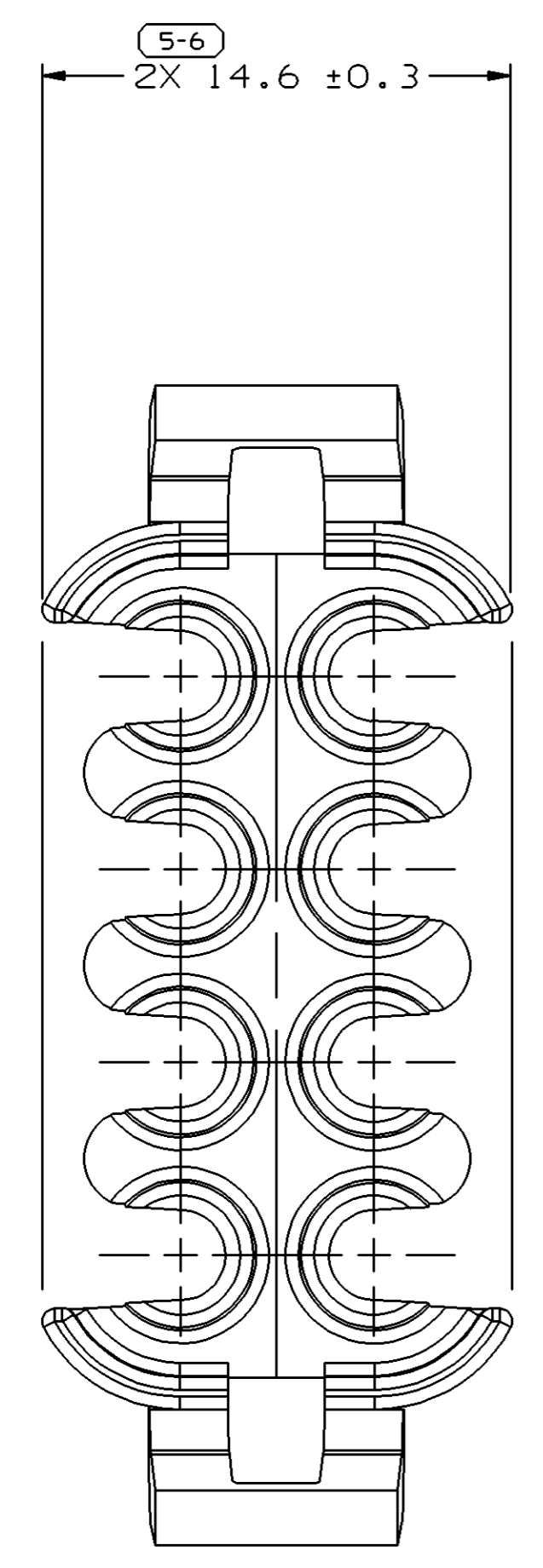
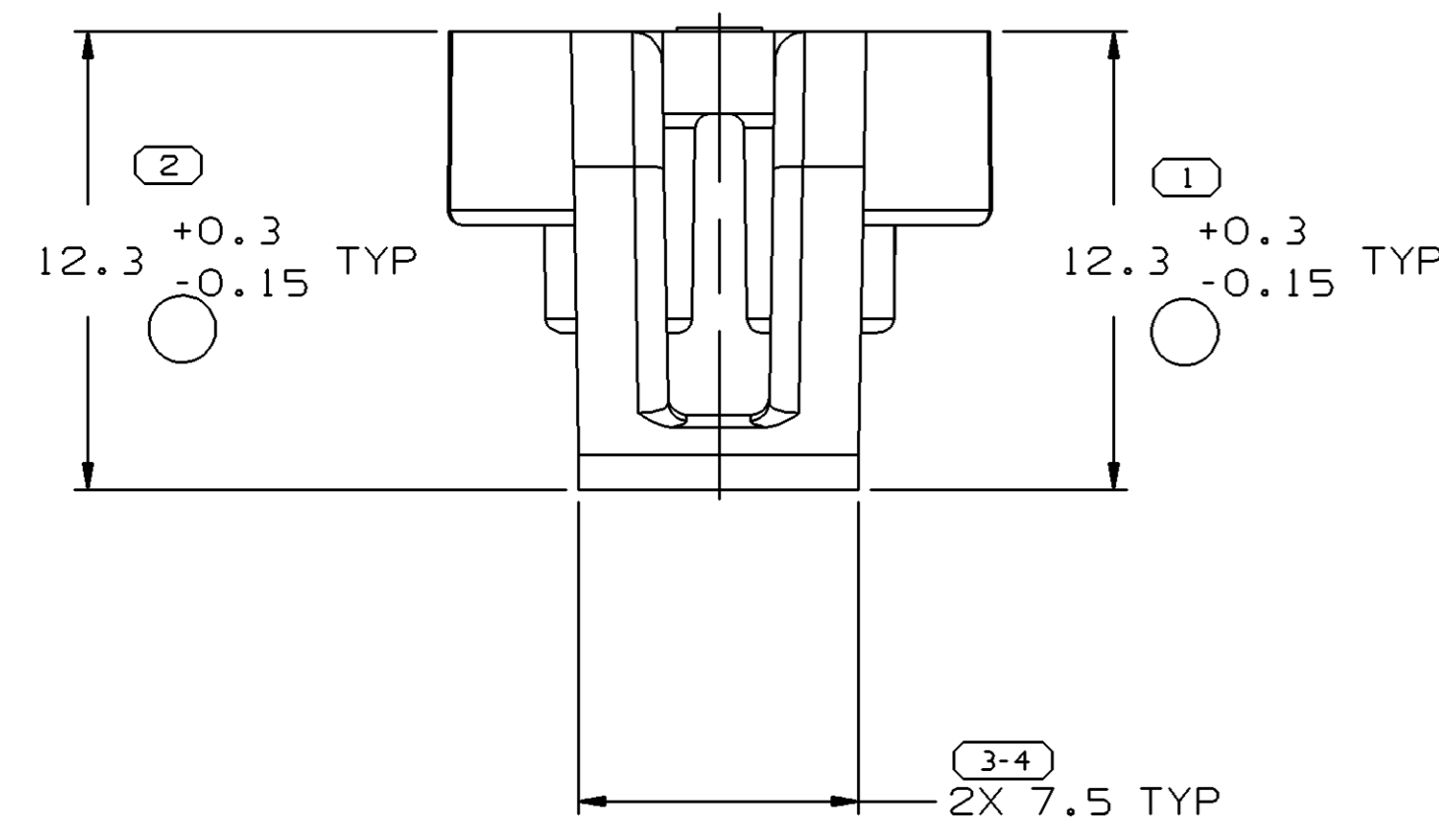
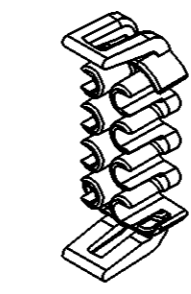



15324525	A4		R0071754 PA66 HS IM-BLK	1.139
12186737	B6		R0071790 PA66 HS IM-BLU	1.139
PART NO	REV	STATUS	MATERIAL SPECIFICATION AND COLOR	VOL CM <sup>3</sup>

DIMENSIONAL RANGE (MM)		CHART E1	
FROM	TO	FROM	TO
>0	>20	>100	>300
>20	>30	>150	>400
>30	>70	>200	
>70	>100	>250	
>100	>150	>300	
>150	>200		
>200	>250		
>250	>300		
>300	>400		

TOLERANCE UNLESS OTHERWISE SPECIFIED

±0.15	±0.2	±0.3	±0.4	±0.5	±0.6	±0.8	±1	±1.2
-------	------	------	------	------	------	------	----	------

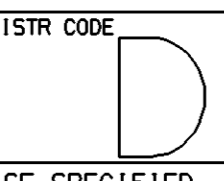
ANGULAR TOLERANCE ±2°

DWG TYPE PART DRAWING	
STYLE	
VOLUME (CM <sup>3</sup> ) SEE CHART	DISTR CODE 
UNLESS OTHERWISE SPECIFIED THIS DOCUMENT IS IN ACCORDANCE WITH ASME Y14.5M-1994 AS AMENDED BY THE GM GLOBAL DIMENSIONING AND TOLERANCING ADDENDUM-2001. SEPARATE PATTERNS OF FEATURES MAY BE GAGED SEPARATELY REGARDLESS OF DATUM REFERENCES.	
ALL DIMENSIONS ARE IN MILLIMETERS	
THIRD ANGLE PROJECTION	
DO NOT SCALE	
USE MATH DATA	

<b>DELPHI</b>	
DELPHI PACKARD ELECTRIC SYSTEMS WARREN, OH	
DR	DATE
APVD1 R. GUTIERREZ	09SE98
APVD2 G. MACIAS	09SE98
APVD3 J. REIDER	19NO98
APVD4	
APVD5	
SUBSTANCES OF CONCERN AND RECYCLED CONTENT PER DELPHI 10949001	
MATERIAL SEE CHART	
DRAWING NAME TAXI LOCK TPA M/P 150	
DRAWING NUMBER 15324539	
SIZE A1	SCALE 5:1
FRAME NO 1 OF 1	SHEET NO 1 OF 1
STG R	REV 04
N/P -	