

SYMBOL DEFINITION		MISSING SYMBOLS	
A DIMENSION WITHOUT AN INSPECTION REPORT SYMBOL DOES NOT REQUIRE INSPECTION. IT MAY BE CONTROLLED ON THE INDIVIDUAL COMPONENT DRAWING.	TOTAL NO OF INSPECTIONS REQUIRED	NO MISSING SYMBOL NUMBER	
	31		
	LAST NO. USED		
	14		

DWG STATUS				REVISION HISTORY				AUTH		DR		APVD	
DATE	STG	REV	W/P	CHG	ZONE								
09JUL02	R	D3	-	-		REDRAWN TO PD, MAT'L SPEC WAS R0064366 PA6 GRA MD, ADDED DELPHI CORPORATE BRAND AND MATERIAL RECYCLING CODE LOGO & ADDED NOTES (2 PLCS)	227085	RVP	RVP	ET			
04SEP02	R	05	-	-		MAT'L SPEC WAS M3596003 PA6 GRA MD	230157	RVP	RVP	OMC			
13JAO3	R	05	AA	-		REVISED DIMENSION LOCATION (4 PLCS)	235461	EOV	RH	ET			

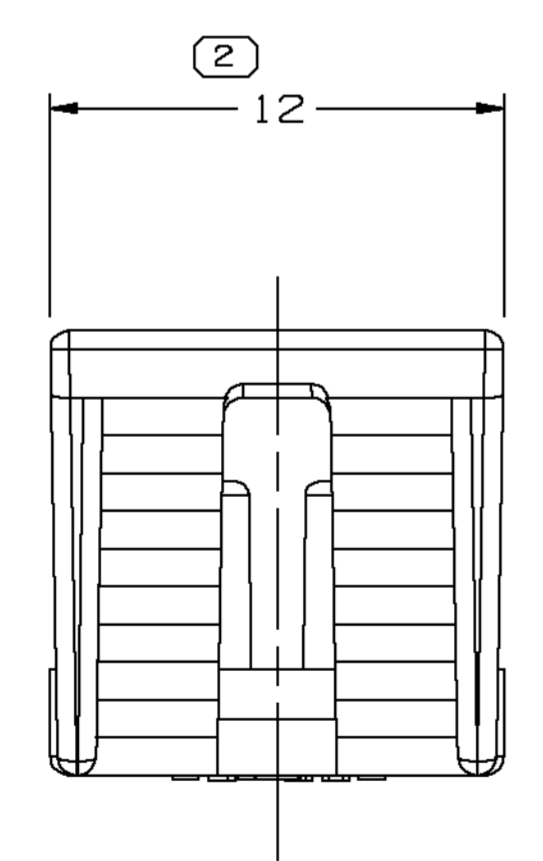

- NOTES
- UNLESS OTHERWISE SPECIFIED AND/OR INDICATED: DIMENSIONS ARE TO FACE OF VIEW SHOWN AND AUTOMATICALLY ROUNDED BY COMPUTER FOR INSPECTION (SEE MATH MODEL FOR PRECISE DIMENSIONS). FOR ALL OTHER DIMENSIONS NOT SHOWN BUT REQUIRED FOR TOOL BUILD, SEE MATH MODEL FOR PRECISE TOOL PATH DATA. ALL RADII 0.4. DRAFT IS 1° MAX ON ALL OUTSIDE SURFACES. LIKE CAVITIES ARE IDENTICAL. LOCKING FEATURES ARE IDENTICAL.
  - MATERIAL RECYCLING CODE >PA66< PER SAE J1344. (2.3)X(0.1) RAISED CHARACTERS AS SHOWN TO BE LOCATED ON ANY EXTERIOR SURFACE. OPTIONAL CONSTRUCTION TO BE NO MATERIAL RECYCLING CODE.
  - THIS PART IS NOT CONTROLLED FOR AUTOMATIC FEEDING.
  - MATING COMPONENTS OR EQUIVALENT: CONNECTOR 12052848, 12052849
  - (2.3)X(0.1) RAISED DELPHI CORPORATE BRAND TO BE LOCATED ON ANY EXTERIOR SURFACE, PREFERABLY VISIBLE AT FINAL ASSEMBLY. OPTIONAL CONSTRUCTION TO BE "PED" OR NO LOGO.
  - MAXIMUM CABLE DIAMETER FOR THIS PART IS 2.8 MM DIAMETER.

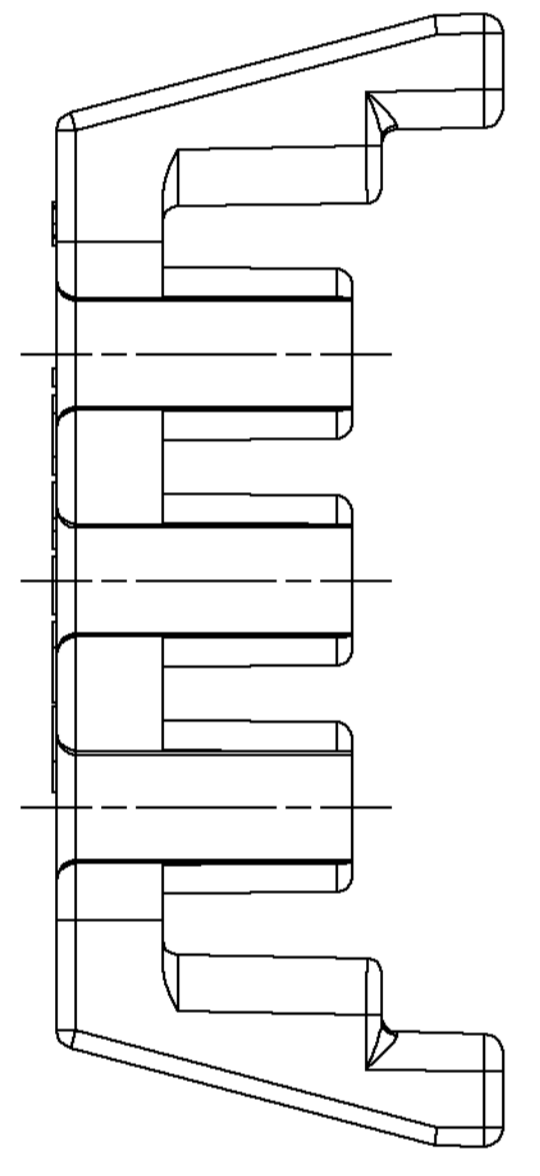
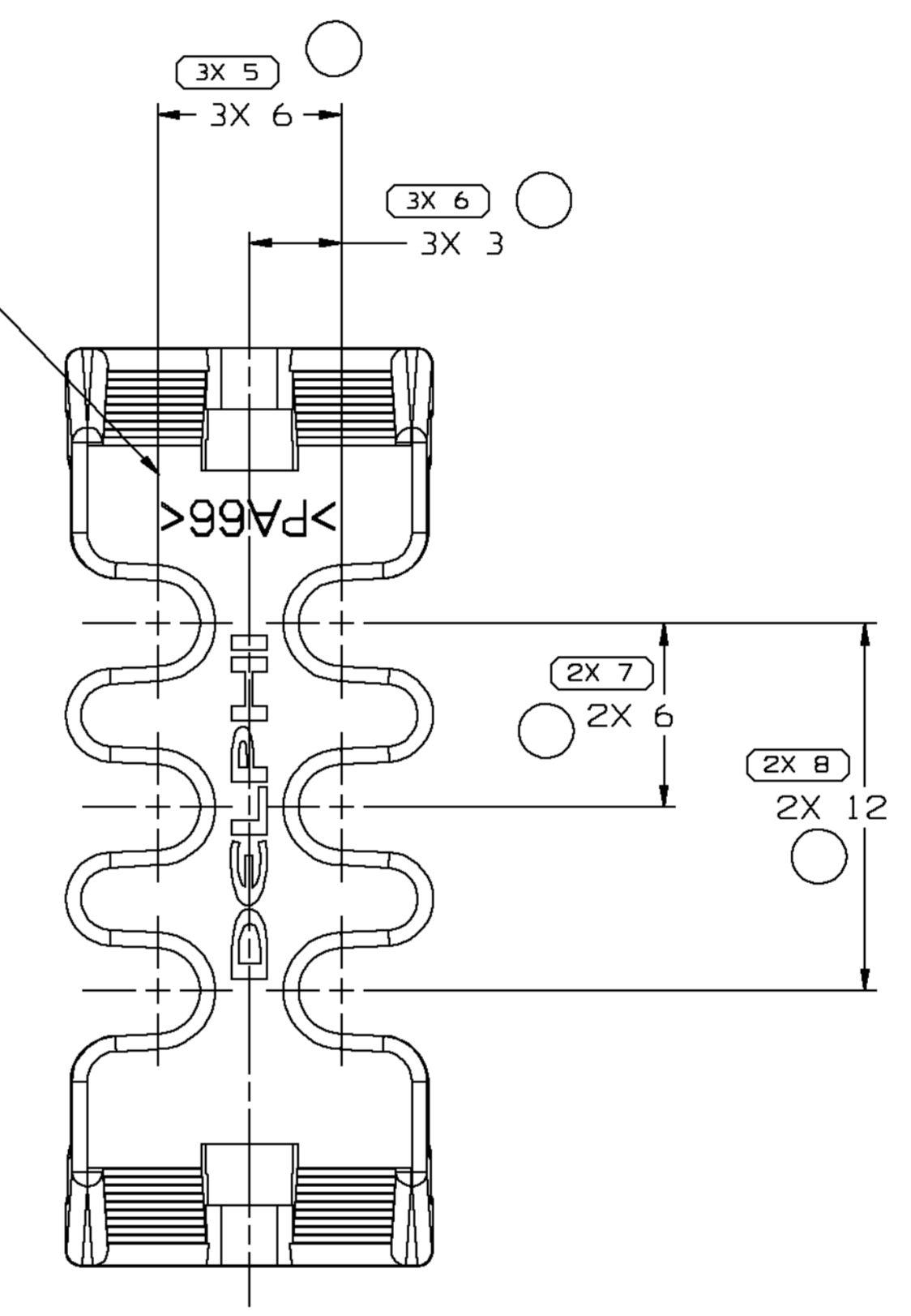
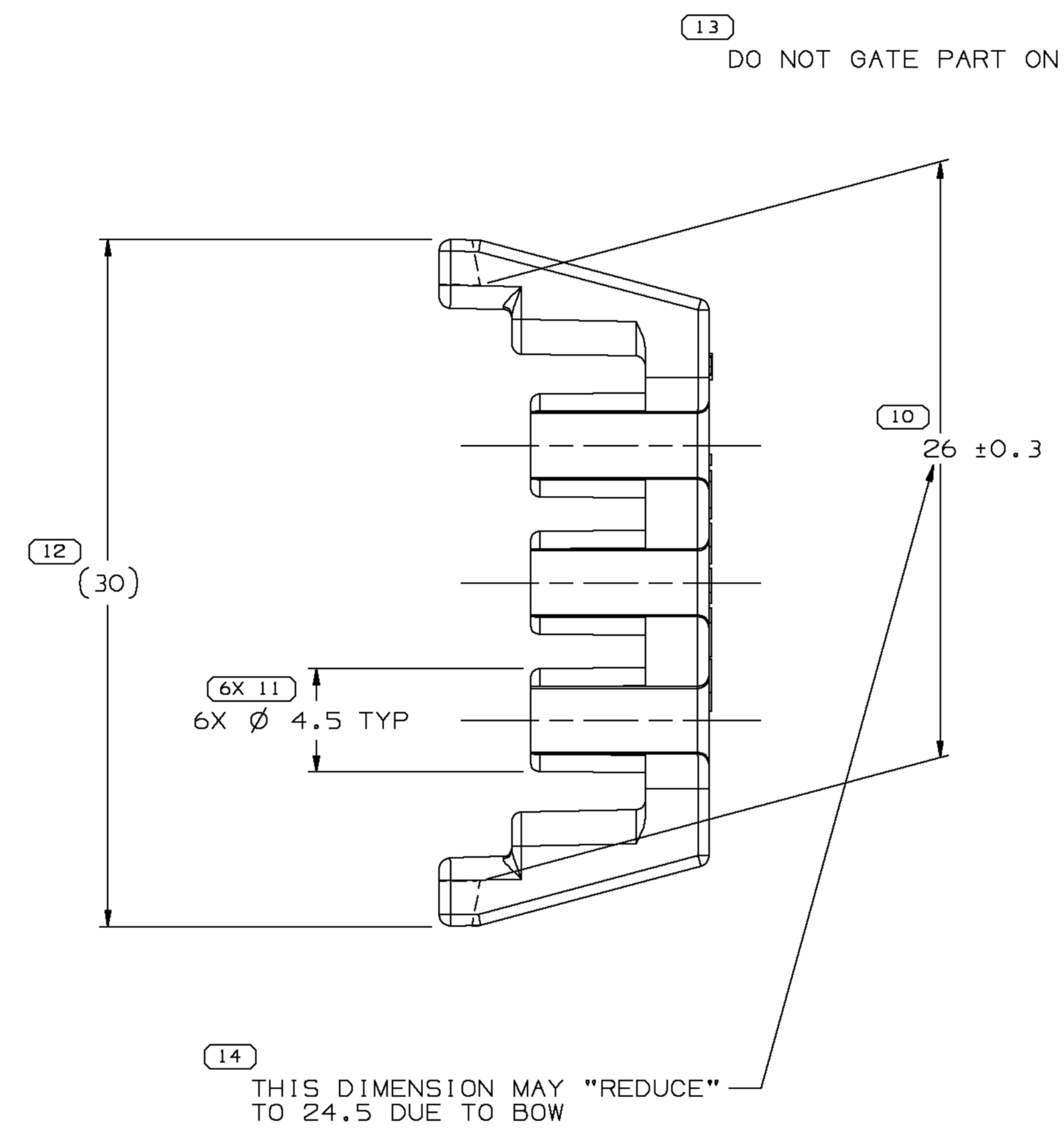
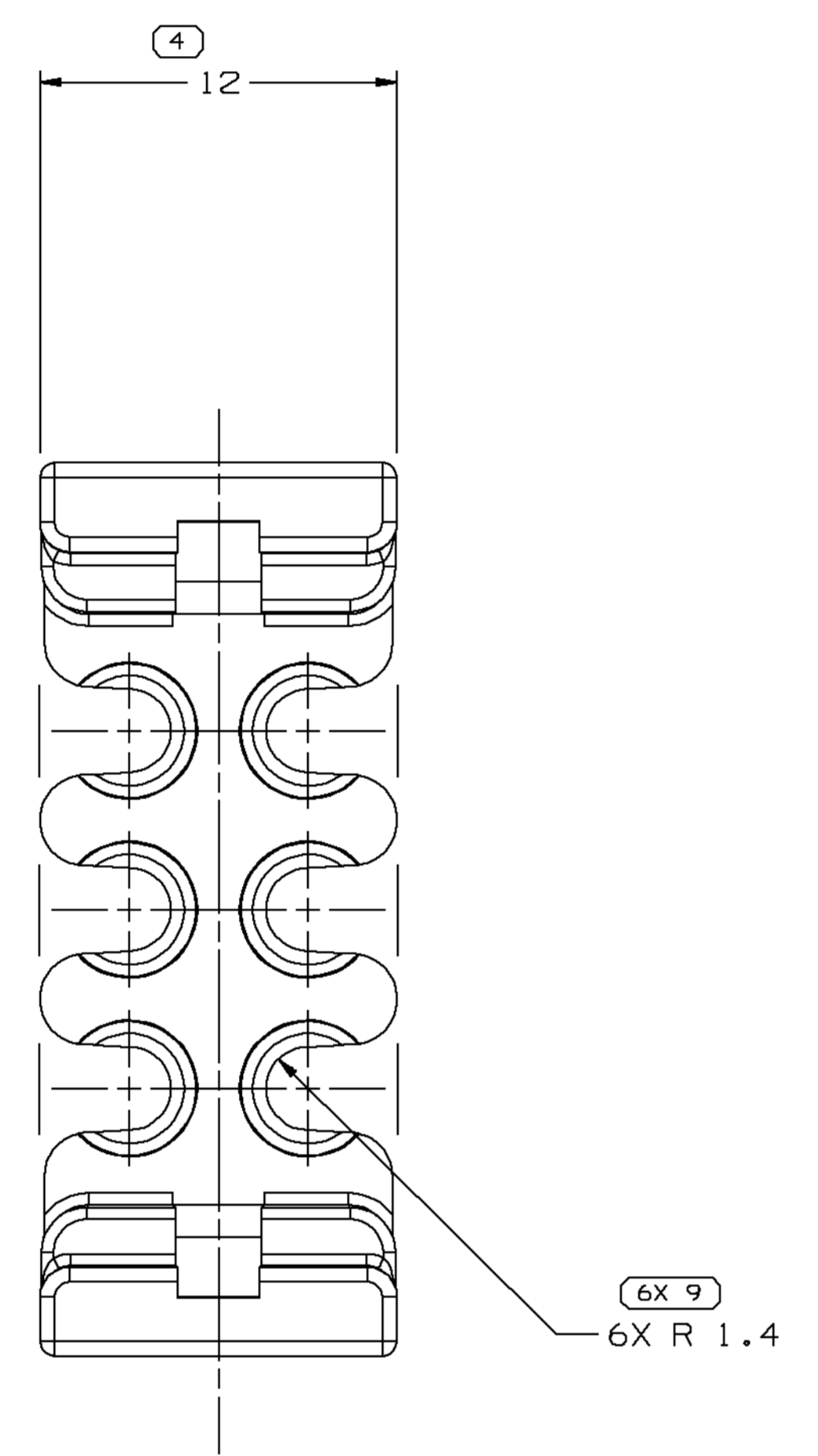
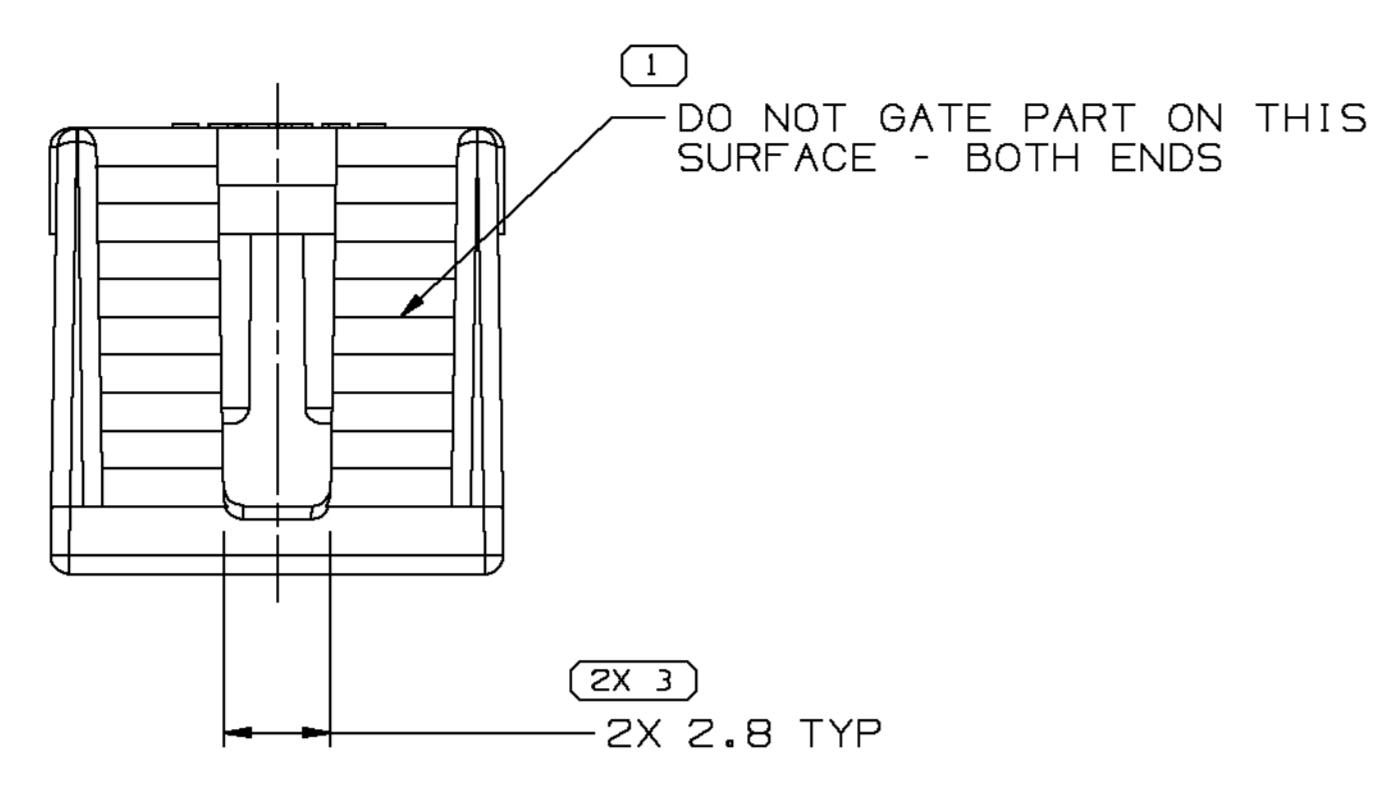
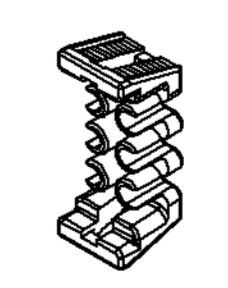

DIMENSIONAL RANGE (MM)		CHART		ET	
FROM	TO	1	2	3	4
0	20	0.1	0.15	0.2	0.3
20	30	0.15	0.2	0.3	0.4
30	70	0.2	0.3	0.4	0.5
70	100	0.3	0.4	0.5	0.6
100	150	0.4	0.5	0.6	0.8
150	200	0.5	0.6	0.8	1.0
200	250	0.6	0.8	1.0	1.2
250	300	0.8	1.0	1.2	1.5
300	400	1.0	1.2	1.5	2.0

DWO TYPE		PART DRAWING	
STYLE	1,27B	DISTR CODE	D
VOLUME (CPI)	6900		
ROUTING			

**DELPHI**  
DELPHI PACKARD ELECTRIC SYSTEMS  
WARREN, OH

DR	DATE
APVD1 R. SEMINARA	23JAB5
APVD2 F. HESTON	25JL85
APVD3 R.H. PARKHURST	31JL85
APVD4	
APVD5	

MATERIAL: M3592025 PA66 H5 1M GRA MD

DRAWING NAME: LOCK TERM LK TPA 3 GRA MD

DRAWING NUMBER: 12052850

SIZE: A0 SCALE: 5:1 FRAME NO: 1 OF 1 SHEET NO: 1 OF 1 REV: 05 AA