

To Include:
 5/16-18 Bolt
 P/N 6700T
 5/16-18 Nut
 P/N 6701T

21/32"
 [16.5mm]
 Dia. Ref

Prefilled With
 Rosin & Solder

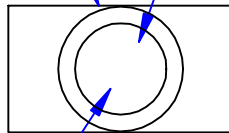

I.D. Sized For 3/0
 [81mm²] Stranded Cable
 7/8" [22.2mm] Min Depth

Sized for Neg. Post

Cable Size
 Stamp

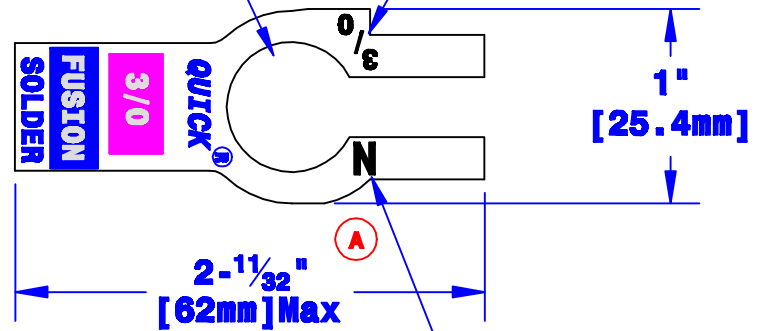

Polarity
 Stamp

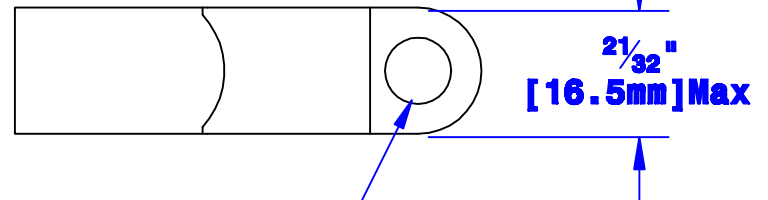

Bolt Hole Sized
 For 5/16" [M8] Bolt

Property of QUICKCABLE 3700 Quick Drive Frankville, WI 53126 U.S.A. www.quickcable.com	TITLE Die Cast 3/0 Ga. Straight Clamp, Fusion
	PART # 406330N

Confidential and Proprietary Information

					Drawn By JIM H	Date 8-08-07	Checked By Mike E	Scale None	Material & Treatment High Conductivity Copper Alloy Matte Tin Plate	Drawing # 406330N-Info	REV A
A	02-25-09	1759	JMH	Update print; remove one notch; shorten tangs	Tolerances, unless otherwise noted Dimensions are reference only					Sheet 1 of 1	
Rev	Date	ECN#	By	Description							